

FAIRBANKS NATIVE ASSOCIATION

2024 ALASKA NATIVE YOUTH
BASKETBALL TOURNAMENT



MARCH 11 - 13, 2024
TANANA MIDDLE SCHOOL



This page is dedicated to the late Daphne Gustafson.

Daphne Gustafson served the JOM Program for 10 dedicated years, five of which were at the helm of program director.

Daphne worked for change and opportunity for Alaska Natives since the 1960s, and served on FNA's Board of Directors.

She also served on the first board of directors for the Tundra Times, a now-defunct Alaska Native-owned newspaper that covered Alaska Native issues more thoroughly than other news.

She worked tirelessly for Alaska Native People and was an advocate for children's education.





Welcome Back!

This year's JOM Basketball Tournament is dedicated to Daphne Gustafson. Daphne was part of Fairbanks Native Association from the beginning. At the time of her retirement, Daphne was the Program Director of the Jonson O'Malley Program. Daphne's impact and presence is continuously felt. Daphne will be missed.

Thank you for participating in the 23rd Annual JOM Alaska Native Youth Basketball event. Basketball has always been a great opportunity to bring friends and families together and to also build new long-lasting friendships. The event's purpose is to give our community the opportunity to enjoy watching our youth play a game they love and playing with other village players across the great state of Alaska. This event is divided into (3) co-ed divisions: Elementary 3rd-5th, Middle 6th-8th and High School 9th-12th.

We have built (3) Brackets, with 7-9 teams for each Division. Teams were selected by an experienced Tournament Manager who has for 30 plus years coached Comp Youth Basketball, Eddie Puryear. Each team roster has 8-9 players, allowing all players to play at least (2) quarters each game. Sportsmanship is our top priority throughout this great tournament. We have 67 Youth Players from Alaska Villages, which is 35% of our student players, Congratulations.

This event is hosted by Fairbanks Native Association Johnson O'Malley Program (JOM) with the help of many, many community Volunteers and JOM Leadership Students from our local schools. Year after year, volunteers help with coaching, score and timekeeping, hall monitoring, concessions, setting up, and cleaning up after each day of the event. Without you, this event would not be possible! **Baase'e!**

This great and well-attended event would not be possible without our Amazing Sponsors: Doyon, Tanana Chiefs Conference, Chevy of Alaska, Gana-Ayoo Corp, Denali State Bank, Cold Spot Feeds, AK Laborers Union, Youth Sports, Teamsters, GHEM Corp, Ron's Chevron, Cookie Jar, Chena Hot Springs Resort, Amped Electric and Ahtna Construction.

Invite your family, friends, neighbors, and of course our Elders. Welcome Back JOM Basketball players, parents, and the surrounding Alaska villages from across the great state of Alaska.

With Sincere Appreciation,

JOM Staff:

Mary Willey, JOM Director	Tyler Brooks, Tech Support Coach	Evan Divine, North Pole Middle	Peggy Kuryla, Denali Elem
Cecilia "Babes" Hudson, Manager	Alicia Kangas, Hunter	Isabelle Green, Anne Wien	Tsi-yaa Cuny, Effie Kokrine
Rebekah Jackson, Manager	Andrew Troppman, West Valley High	Donghak Mark Kim, Lathrop	Wyatt Wilcher, Ryan Middle
Fawn Wyatt, Program Assistant			

3830 S. Cushman Street, Fairbanks, AK 99701

* Phone 907-452-1648 * Fax 907-479-0215 www.fairbanksnative.org *

Rules - 2024 JOM Native Youth Tournament

All players must have a signed "Waiver of Liability" on file with JOM.

- No jewelry allowed on the court.
- All teams are allowed 1 coach and 1 assistant coach. Only 1 coach may be standing during the game.
- **Coaches** are responsible for team promptness and jerseys.
- **Coaches** will not verbally abuse players, referees, or anyone else on the bench or on the premises of the school.
- **Parents** MAY NOT leave students unless they are in 6th-12th grade.
- **Parents** are responsible for providing food/drinks/snacks for their player.
- **Parents** are responsible for ensuring their student(s) leave the gym at the end of the final game each day. *Please check the schedule daily.*
- NO PERSONAL BASKETBALLS BEYOND THE FRONT DOOR. Illegal basketballs will be confiscated and returned at the end of the tournament.
- Teams will be FROZEN when the tournament begins. NO LATE ADD ONS.
- The **tournament manager** will make the FINAL decisions on players placement and re-assigning to new teams, if needed.
- If there is a 2nd technical foul on a player, that player will be removed from the game. If this reoccurs multiple times, that player will be ejected from the tournament.

Remember to treat each other with courtesy and respect and refrain from any negative comments about players, parents, coaches, referees, or any other JOM staff or volunteers.

Elementary Teams

- (4) 9 Minute Quarters
- (5) Personal Fouls Allowed
- (5) Seconds in the key
- (3) Minute Half Time

Pressing allowed only in the 4th Quarter.

(2) girls must be on the court the entire 4th Quarter.

ALL players must play 2 full quarters.

Middle School Teams

- (4) 9 Minute Quarters
- (5) Personal Fouls Allowed
- (3) Seconds in the key
- (3) Minute Half Time

Open Press

(2) girls must always be on the court.

ALL players must play 2 full quarters.

High School Teams

- (4) 9 Minute Quarters
- (5) Personal Fouls Allowed
- (3) Seconds in the key
- (3) Minute Half Time

Open Press

(1) girl must always be on the court.

ALL players must play 2 full quarters.

Running Clock: Clock stops during timeouts and/or last (2) minutes of the 4th quarter within a 5-point spread.

Mercy Rule: 30-point spread “Clock DOES NOT STOP for all divisions.

Overtime: (3) minute running clock. Each team gets 1 timeout (clock will stop for timeout).

Double Overtime: Sudden Death Rule - 1st team to score (3) points wins.

Timeouts: Coaches get 2 timeouts each half. Clock stops during timeouts.

ELEMENTARY SCHOOL TEAMS

STUDENT NAME	GRADE	SCHOOL	HEIGHT
FAST BREAK/CAROLYN WALKER			
Alexander, Ronald	5	Minto School	
Johnson, Ellaina J.	5	Yakutat Elem.	4'5
Johnson, Gracie A.	4	Yakutat Elem.	4'5
Joseph, Jackson H.	4	North Pole Elementary School	4'10
Walker, Max	4	Connections Homeschool	4'10
Welton, Brandon "Noah"	4	Anne Wien Elem.	
Roberts, Avery	3	Minto School	3'11
Winfrey, Jordanna L.	3	Hunter Elementary	4'1
RIVER RUNNERS/ANDREA NIELD			
Kubanyi, Renee K.	5	Denali Elementary	4'8
Demoski, Avery L.P.	4	Woodriver Elementary	4'10
Nield, Ian	4	Woodriver	5'1
Nield, Mary	4	Woodriver Elementary	4'8
Gibson, Isaiah T.	3	Anne Wien Elem. School	4'6
Thomas, Grayson S.	3	Ticasuk Brown	4'11
Thurman, Laken	3	Weller Elem. School	4'2
CRAZY HORSE/TOD KOZEVNIKOFF			
Agnes, Carrie	5	Tanana	5'0
Bergman, Gordon S.	5	Allakaket School	5'0
Green-Warner, Mia	5	Galena/GILA	5'0
Moses, Aubrey B.	5	Weller Elem. School	5'2
David, Jayce	4	Minto School	4'5
Huntington, Kaysen R.	4	Woodriver Elementary	4'10
Lord Tiepelman Mancuso, Amedeo	3	Monroe	4'7
Tanner, Verek	3	Chinook School	4'3
NATIVE PRIDE/C MICHAEL HARRIS			
Lie-Olin, Blaine	5	Weller Elem.	4'6
Bostwick, Tabitha D.	4	Anne Wien Elem.	4'7
Harris, Zayen	4	Nenana City School	4'7
Solomon, Natalie	4	Denali Elementary	5'2
Aloysius, Ava D.	4	Sidney Huntington Elem.	5'2
Derendoff, Tyrion J.	3	Hunter Elementary	
Evans, Samuel T.	3	Barnette Magnet School	4'10
Joseph, Aziah W.	3	Denali Elem.	4'5

ELEMENTARY SCHOOL TEAMS

STUDENT NAME	GRADE	SCHOOL	HEIGHT
LIL DRIBBLERS/DONNA REXFORD			
Billings, Josiah R.	5	Galena City School	4'11
Titus, Jr. Jamey C.	5	Walter Northway School	4'6
Martino, Austin	4	Monore	4'9
Thomas, Ivan	4	Woodriver Elementary	5'2
Titus, Jerren P.W.	4	Minto School	5'
Woods, Alara Grace	4	Minto School	5'4
Rexford, Penelope L.	3	University Park Elem.	5'0
Peter, Genevieve	3	Ft. Yukon School	4'2
NATIVE NANOOKS/ZACH CARROLL			
Captain, Jennifer M.	5	Hunter Elementary	5'
Engler, Christian	5	Cyberlynx	4'9
Evans, Jason B.	5	Denali Elementary	5'1
Wards, Evander	5	Ticasuk Brown	5'1
Kennedy, Violet C.	4	Maudery J.Sommer School	4'11
Carroll Tanner J.	3	Hunter Elementary	5'0
Wigley, Madison V.	3	North Pole Elementary School	4'10
Aloysius, Lacy C.	3	Sidney Huntington Elem.	4'4
AK FISH & WATER/DEZ REDFOX-SHANNEL KOVALSKY			
Frank, Cache C.	4	Barnette Magnet School	4'1
Irwin, Brooklyn N.	5	Homeschool	4'11
Lee, Aurora	3	Ann Wein Elem.	4'8
Roberts, Kyla	5	Minto School	3'11
Silas, Keenan	3	Hunter Elementary	
Sommer, Colton	4	Weller Elmen.	4'10
Thomas, Domani B.	5	Northway	4'10
Vaden, Carter	4	Midnight Sun Elem.	4'10
EAGLES/KAYDENCE SHEWFELT			
Cleaver, Kamea E.	5	Sidney Huntington School	5'0
Pierce, Rylee M.	5	Waller Elementary	5'3
Thomas, Anothony	5	Pearl Creek Elementary	5'0
Wigley, Joseph A.	5	North Pole Elementary School	5'0
Baker, Liam L.	4	Minto School	5'2
Gallen, Randy W	4	Ticasuk	4'11
Johnson, Talia N.	3	Yakutat Elem.	4'3
Rueben, Duane P.	3	University Park Elem.	4'7

Elementary Bracket

All Elementary games are played in Gym 2, except for the Championship Game.

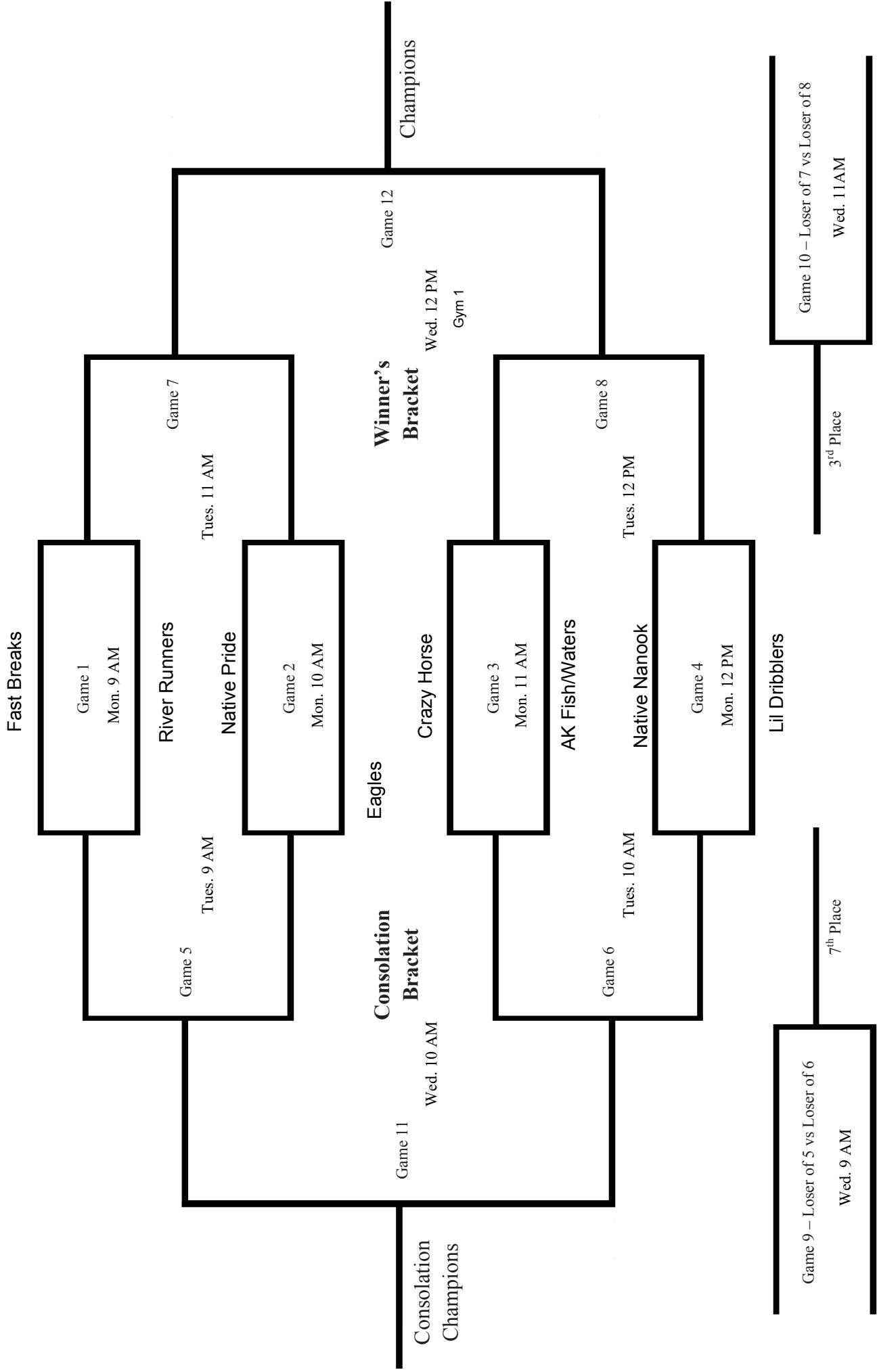

MIDDLE SCHOOL TEAMS

STUDENT NAME	GRADE	SCHOOL	HEIGHT
YUKON WARRIORS/TRAVIS N KRISTEN MORELAND			
Moreland, Billie	8	Ryan Middle School	5'2
Vent, Gordon K.A.	8	Jimmy Huntington School	5'8
Ford, Kaiden	7	Ryan Middle School	5'7
Frank, Gunner S.	7	Barnette Magnet School	5'1
Martino, Payton	7	Monore	4'11
Moreland, Taegan	7	Ryan Middle School	5'2
Thompson, John M.	7	Dot Lake	5'6
Kubanyi, Victor K.	6	Ryan Middle School	4'10
YUKON THUNDER/EVAN N THEA PURYEAR			
Edwardsen, Paul A.	8	Maudrey J. Sommer	5'11
Folger, Brooklyn E.	8	Ryan Middle School	5'5
Jimmie, Russel J.	8	Walter Northway	
Vent, Shiona E.	8	North Pole Middle School	5'2
Derrickson, Gisele	6	Ryan Middle School	5'8
Edwin, Delaney	6	Maudrey J. Sommer	5'3
Snow, Ian	6	Monore	5'0
Tanner, Valek	6	Chinook School	4'10
WOLFPACK/			
Aiken, Billie K	8	Tanana Middle School	5'2
Kubanyi, Verko M.	8	Ryan Middle School	5'6
Nutting -Titus, Evan O.C.	8	Walter Northway School	5'10
Wittenkeller, Joseph H.	8	Tanana Middle School	5'3
Edwardsen, Lucas	7	Maudrey J. Sommer	5'3
Engler, Alexis	7	Ft. Yukon School	4'11
Jimmie, Billie J.	7	Walter Northway	
Peterson, Zariah R	6	Ryan Middle School	
Thurman, Olivia	6	Tanana Middle School	4'7
VILLAGE BALLERS/ZACH CARROLL			
Petersen, Seth N.	8	Ft. Yukon School	6'0
Torres, Marvin	8	Ryan Middle School	5'8
Vent, Lyla M.M.	8	Jimmy Huntington School	5'7
Woods, Bruce J	8	Ft. Yukon School	4'10
Shewfelt, Gisele S.M.	7	North Pole Middle School	5'4
Titus , Layla J.	7	Walter Northway School	5'4
Vaden, Jada	7	North Pole Middle School	5'3
Charlie, Cerosky M.	6	North Pole Middle School	5'3
Kriska, Kaysen K.	6	Monroe School	4'10

MIDDLE SCHOOL TEAMS

TIGERS/LAINA MADROS

David, LaShawn	8	Minto School	5'9
McKinney, Azriel T.	8	Tanana Middle School	5'6
Wilbur, Alden	8	Ryan Middle School	5'7"
Baker, Tayla L.	7	Minto School	5'3
Madros, Isabelle K	7	North Pole Middle School	5'3
Madros, Lisabeth R.	7	North Pole Middle School	5'3
Thomas, Steven	7	Tanana Middle School	5'1
Dozette, Karissa	6	Randy Smith Middle	5'1

MINI BALLERS/BETH ALEXANDER

Baker, Brielle A.	8	Minto School	5'4
Dozette, Chace	8	Ryan Smith Middle School	5'4
Hanson, Malaki	8	Tanana Middle School	5'7
Wholecheese, La'trill	8	Huslia	5'6"
Aloysius, MaKayla R.	7	Sidney Huntington Elem.	5'6
Cadzow, Trapper	6	Ft. Yukon School	4'10
David, Lenora	6	Minto School	5'4
Folger, Brenna T.	6	Ryan Middle School	5'6
Haynes, Matthew M. Jr.	6	Ryan Middle School	5'5

HOT SHOTS/AMOS FRANK

Bigfoot, Curtis Peter James	8	Ryan Middle School	5'5
Demit, Allison	8	Tok School	5'3
Derendoff, Quentin R.	8	Effie Kokrine	5'7
Irwin, Brayden J.	7	Homeschool	5'1
Moses, Catherine J.	7	Tanana Middle School	4'11
Adams, Dyani R	7	Ryan Middle School	5'2
Frank, Ladainian	6	Ryan Middle School	5'5
Titus, Traeton	6	Minto School	5'4

HAPPY CAMPERS/KATRINA GENS

Cadzow, Heidi E.	8	Ft. Yukon School	5'0
Nicholas, Brayden Robert	8	Effie Kokrine	5'5
Snowden, Leann	7	Ryan Middle School	5'1
Tansy, Max W.	7	Tanana Middle School	5'10
Teasdale, Riley J. T.	7	Raven Home School	5'6
Titus, Evangeline	7	Effie Kokrine	5'2
Demit, Natasha	6	Tok School	4'6
Gens, Xavier B.	6	North Pole Middle School	4'11
Obed, Helena C	6	Randy Smith Middle	

ALLEY OOPS/C MICHAEL STEVENS

Fernandes, Jeremy G.	8	Ft. Yukon School	5'10
Griffin, Josslyn	8	Randy Smith Middle	5'5
Harris, Destiney A.	8	Nenana City School	5'4
Roberts, Nicholas Jr.	8	Minto School	5'8
Boyd, Cherish	7	Tanana Middle School	5'4
McCallum, Josiah	7	Effie Kokrine	5'6
Volavong, Sean J.	7	North Pole Middle School	5'7
Edwardsen, Natasha S.S.	6	Maudrey J. Sommer	5'3

Middle School Bracket

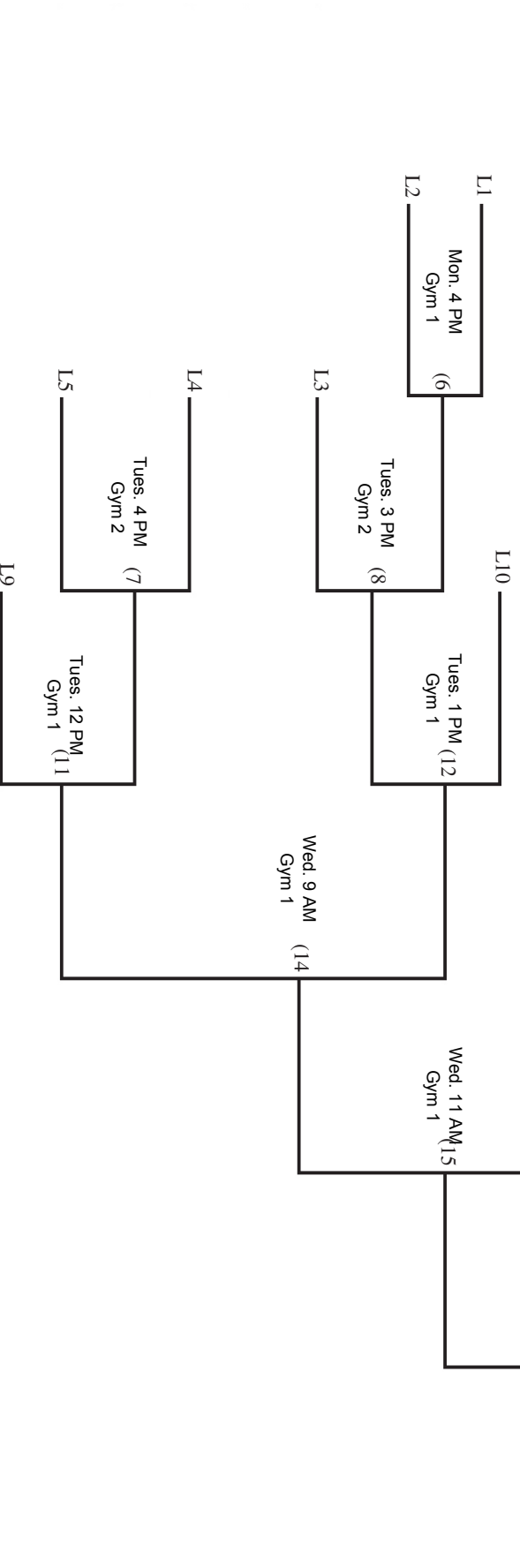
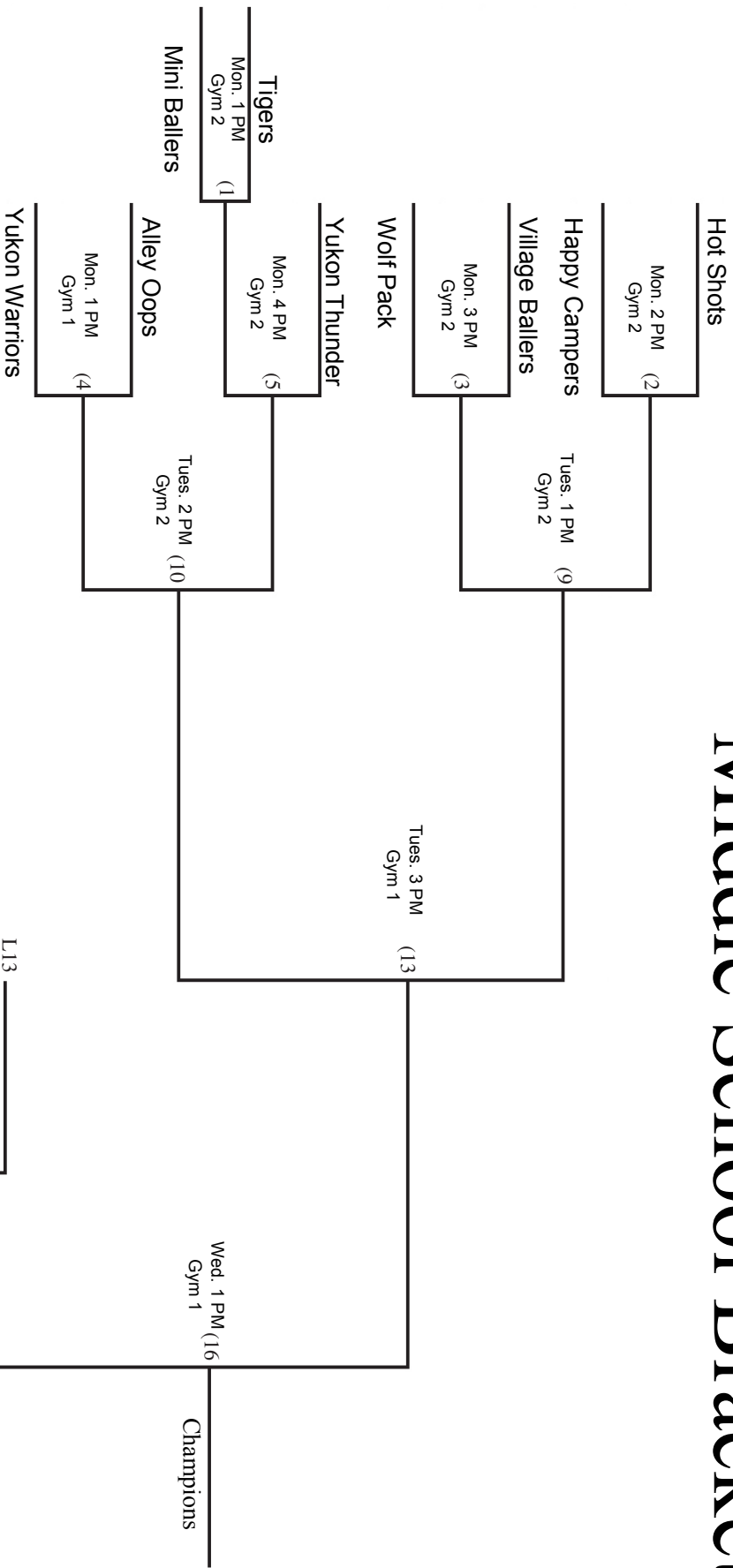

HIGH SCHOOL TEAMS

STUDENT NAME	GRADE	SCHOOL	HEIGHT
GRIZZLY BEARS/WES ALEXANDER			
Riley, Isaiah C.	12	Raven Correspondence School	5'9
Moreland, Nevaeh	11	Career Edu. Center	5'9
Steven, Evan T.	11	Effie Kokrine	5'5
Wigley, Elijah M.	11	North Pole High School	5'8
Bessette, Nick C.	10	West Valley High School	5'8
Brodin, Demarcus A.	10	Walter Northway	5'10
Alexander, Blaze B.	9	Nenana City School	5'10
Agnes, Frances C.	9	Tanana	5'7
Wholecheese, La'tril	9	Huslia	5'8"
DOYON LEADERS/CHERYL CADZOW			
Shewfelt, Kaydence	12	West Valley HS	5'4
Wholecheese, Stuart D.	12	Allakaket School	5'10
Vent, Ciara, C.	11	Jimmy Huntington School	4'11
Burk, DaShawn D.	11	Nenana High School	5'10
Hendren-Rice, Brandy A.	10	Dot Lake School	5'9
Huntington, Trevon T.	10	West Valley HS	6'2
Kubanyi, John D.	9	Tikigaq High School	5'7
Hall, Devonte J.	9	Lathrop High School	6'0
CHOOSE RESPECT/LINA ALLEN			
McClesky, Ronin J.	12	West Valley HS	6'3
Moore, Thadeus	11	Tanana	5'10
Pitka, Tyler J.	11	Effie Kokrine	5'11
Dozette, Gracie	10	West Valley High School	5'5
Pitka, Ryder A	10	West Valley High School	5'7
Arkell, Julianne K.	10	Lathrop High School	5'7
Goldsberry, Guy	9	Dimond High School	5'10
Cleaver, Camden D.	9	Sidney Huntington School	5'11
CHASING HORSE/ZACH CARROLL			
Pitka-Johnson, Tyrese	12	Effie Kokrine	6'2
Carroll Jr, Jonas	11	Fort Yukon	5'10
Beasley, Brennen W.	11	Lathrop High School	5'10
Cruger, Brayden K.	10	Best Homeschool	5'11
Evans, Michael A.	10	West Valley HS	5'9
Rubke, Chokhyia	10	Effie Kokrine	5'7
Hall, Deshon L.	9	Lathrop High School	5'10
Oktollik, Ava E.M.D,	9	Lathrop High School	5'1
RESERVATION DOGS/EVAN N THEA PURYEAR			
Malamute, Kaydence Ann	12	West Valley High School	5'4
Makkar, Joseph A.	10	Lathrop High School	5'8
Nutting -Titus, Terrence	10	Walter Northway School	6'0
Snow, Isaiah	10	Monore	5'10
Stevens, Alex W.	10	West Valley High School	5'10
Boyles, Olivia Marie	10	West Valley HS	5'4
Huntington, Hayden J.	9	Galena/GILA	6'1
Wigley, Makayla R.	9	North Pole High School	5'5

High School Teams

NATIVE NATION/TODD KOZEVNIKOFF

Eagleshield, Dezmond	12	Career Edu. Center	6'0
Delgado, Anthony A.	11	West Valley HS	5'11
Hanson, Darius K.	10	West Valley High School	5'8
Kozevnikoff, Kierra S.	10	West Valley High School	5'6
Bigfoot, Jimmie D.	10	Effie Kokrine	5'10
Ekada, Peyton J.	9	Nulato	5'8
Luke, Preston	9	Lathrop High School	5'6
Vent, Carmen C.	9	Jimmy Huntington School	5'4

HOOP HUSTLERS/AMOS FRANK

Harding, Sharae E.	12	Best Homeschool	5'11
McManus, Sophie R.	12	Nenana School	5'11
Rockwell, Leland J.	11	West Valley High School	5'10
Sam, Seth E.A.	11	Walter Northway	5'9
Bergman, Sidney L.	10	Allakaket School	5'6
Nield, Halen	10	West Valley HS	6'2
Frank, Maddison	9	Effie Kokrine	5'7
Tansy, Jake D.	9	Lathrop High School	6'0
Aloysius Paxton A.	9	Sidney Huntington Elem.	5'9

Winners' Bracket

High School Bracket

Reservation Dogs

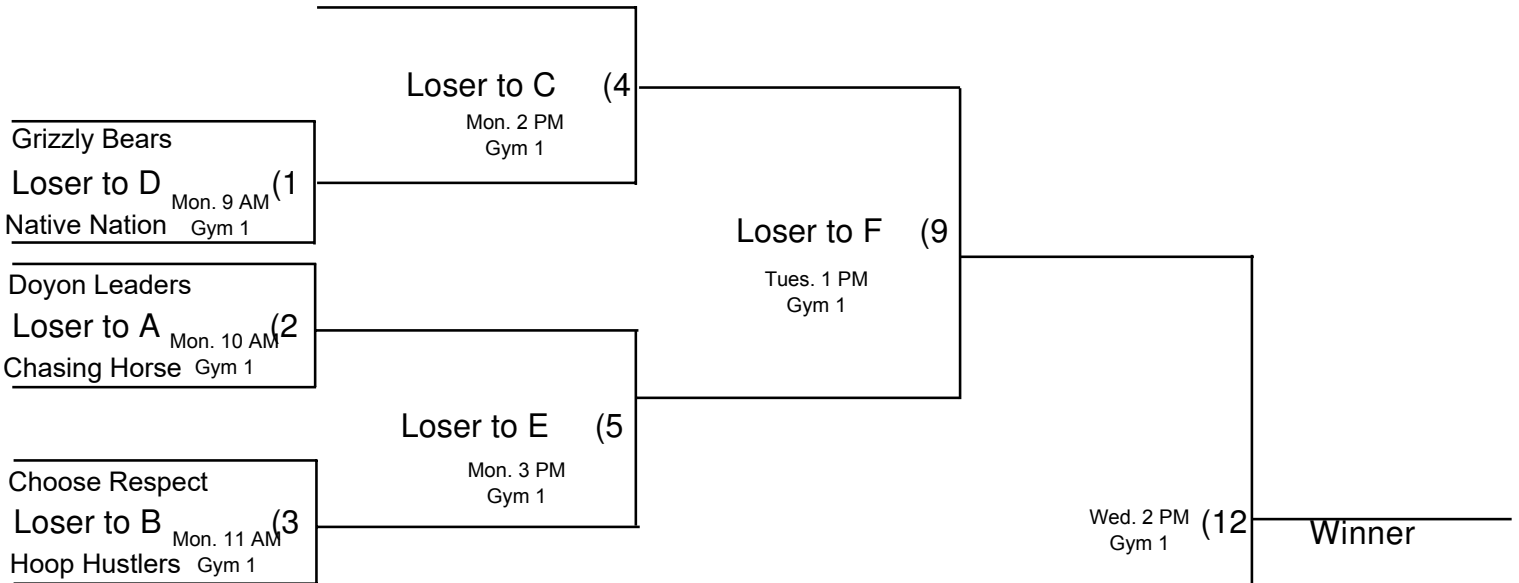

Losers' Bracket

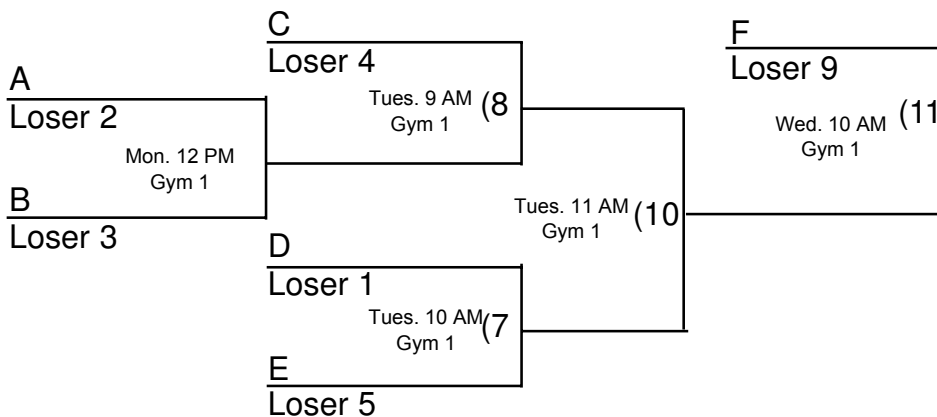

Autograph Page

Good Luck!

We would like to wish all of the athletes the best of luck.

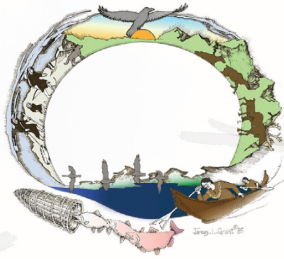

Tanana
Chiefs
Conference

— www.tananachiefs.org —

A proud sponsor of the FNA JOM Basketball Tournament.

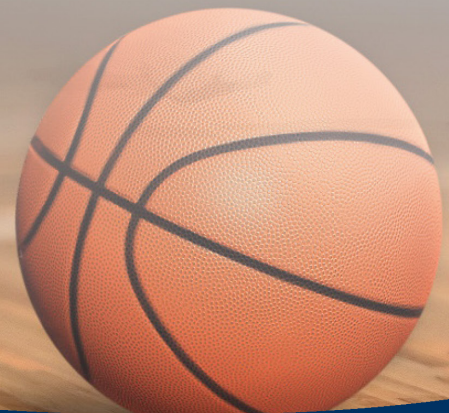



DOYON

— *Limited* —

**Doyon supports
healthy communities.**

Good luck in the games!

1 Doyon Place, Suite 300
Fairbanks, Alaska 99701-2941 907-459-2000, 1-888-478-4755
www.doyon.com



Follow us on social media for up-to-date Doyon, Limited news and events.



Celebrating
over 60 years!

FAIRBANKS NATIVE ASSOCIATION

2024 Annual Potlatch

Saturday, March 16, 5 p.m.

Chief David Salmon Tribal Hall



March 1963
March 2024



FAIRBANKS NATIVE ASSOCIATION

2024 Annual Pageants

Saturday, March 16, 5 p.m.

Chief David Salmon Tribal Hall

Completed application due by March 6, 2024

www.fairbanksnative.org



ONE People ONE Voice

2024 ANNUAL CONVENTION & FULL BOARD OF DIRECTORS MEETING

March 11-14, 2024

Westmark Hotel • Fairbanks, AK



Tanana
Chiefs
Conference

Visit Our Website
to Learn More



ePROXY
PRIZE
Deadline
FEB. 16
5 p.m. AKST

EARLY
BIRD
Deadline
FEB. 16
5 p.m. AKST

PROXY
Deadline
MAR. 12
5 p.m. AKST

VOTE Online
eproxy.doyon.com



Questions?
907-459-2000
www.doyon.com

2024 ANNUAL MEETING of Shareholders



FRIDAY, MARCH 15
DOORS OPEN 8 A.M. AKST
WESTMARK FAIRBANKS HOTEL

Participate online
www.doyon.com



OUR FAMILY TREE

Connected by our roots. Strengthened by our diversity.



**DOUBLE YOUR DOWN
PAYMENT UP TO \$3000!**

**CHEVROLET GMC OF
FAIRBANKS**

VALID ON NEW VEHICLES AT CHEVROLET GMC OF FAIRBANKS. AMOUNT DOWN IN THE FORM OF A
DEALER DISCOUNT. VALID THROUGH 3-31-24

GANNA-A'YOO



AN ALASKA NATIVE VILLAGE CORPORATION

COLD ❄️ SPOT
FOR HEALTHY PETS

Thank you for your sponsorship!



Chevron

Ron's Service and Towing

Auto Service • 24 Hr Towing (9 Units)

101 Noble Street

Fairbanks, Alaska 99701

(907) 456-4224

Bob Weaver
Owner



Thank you for your sponsorship!



**GENERAL
TEAMSTERS
LOCAL 959
STATE OF ALASKA**



Thank you for your sponsorship!



AMPED ELECTRIC

Thank you for your sponsorship!

The Cookie Jar

R E S T A U R A N T



**CHENA HOT SPRINGS
RESORT**

Thank you for your sponsorship!

FAIRBANKS NATIVE ASSOCIATION



GOOD LUCK TEAMS!

FNA JOM



THANK YOU FOR 23 YEARS OF
EXCITING BASKETBALL FUN!